

**PHILIPPINE BIDDING DOCUMENTS**

**Procurement of  
INFRASTRUCTURE  
PROJECTS**

Government of the Republic of the Philippines

**CONSTRUCTION OF COVERED COURT AT  
BARANGAY MAIPALIG  
CITY OF BATAAC, ILOCOS NORTE**

**Sixth Edition  
July 2020**

# Preface

These Philippine Bidding Documents (PBDs) for the procurement of Infrastructure Projects (hereinafter referred to also as the “Works”) through Competitive Bidding have been prepared by the Government of the Philippines for use by all branches, agencies, departments, bureaus, offices, or instrumentalities of the government, including government-owned and/or -controlled corporations, government financial institutions, state universities and colleges, local government units, and autonomous regional government. The procedures and practices presented in this document have been developed through broad experience, and are for mandatory use in projects that are financed in whole or in part by the Government of the Philippines or any foreign government/foreign or international financing institution in accordance with the provisions of the 2016 revised Implementing Rules and Regulations (IRR) of Republic Act (RA) No. 9184.

The PBDs are intended as a model for admeasurements (unit prices or unit rates in a bill of quantities) types of contract, which are the most common in Works contracting.

The Bidding Documents shall clearly and adequately define, among others: (i) the objectives, scope, and expected outputs and/or results of the proposed contract; (ii) the eligibility requirements of Bidders; (iii) the expected contract duration; and (iv) the obligations, duties, and/or functions of the winning Bidder.

Care should be taken to check the relevance of the provisions of the PBDs against the requirements of the specific Works to be procured. If duplication of a subject is inevitable in other sections of the document prepared by the Procuring Entity, care must be exercised to avoid contradictions between clauses dealing with the same matter.

Moreover, each section is prepared with notes intended only as information for the Procuring Entity or the person drafting the Bidding Documents. They shall not be included in the final documents. The following general directions should be observed when using the documents:

- a. All the documents listed in the Table of Contents are normally required for the procurement of Infrastructure Projects. However, they should be adapted as necessary to the circumstances of the particular Project.
- b. Specific details, such as the “*name of the Procuring Entity*” and “*address for bid submission*,” should be furnished in the Instructions to Bidders, Bid Data Sheet, and Special Conditions of Contract. The final documents should contain neither blank spaces nor options.
- c. This Preface and the footnotes or notes in italics included in the Invitation to Bid, BDS, General Conditions of Contract, Special Conditions of Contract, Specifications, Drawings, and Bill of Quantities are not part of the text of the final document, although they contain instructions that the Procuring Entity should strictly follow.
- d. The cover should be modified as required to identify the Bidding Documents as to the names of the Project, Contract, and Procuring Entity, in addition to date of issue.
- e. Modifications for specific Procurement Project details should be provided in the Special Conditions of Contract as amendments to the Conditions of Contract. For easy completion, whenever reference has to be made to specific clauses in the Bid Data Sheet or Special Conditions of Contract, these terms shall be printed in bold typeface on Sections I (Instructions to Bidders) and III (General Conditions of Contract), respectively.

- f. For guidelines on the use of Bidding Forms and the procurement of Foreign-Assisted Projects, these will be covered by a separate issuance of the Government Procurement Policy Board.

## TABLE OF CONTENTS

<b>Glossary of Terms, Abbreviations, and Acronyms .....</b>	<b>5</b>
<b>Section I. Invitation to Bid.....</b>	<b>7</b>
<b>Section II. Instructions to Bidders .....</b>	<b>10</b>
1. Scope of Bid.....	11
2. Funding Information .....	11
3. Bidding Requirements.....	11
4. Corrupt, Fraudulent, Collusive, Coercive, and Obstructive Practices .....	11
5. Eligible Bidders.....	11
6. Origin of Associated Goods .....	12
7. Subcontracts .....	12
8. Pre-Bid Conference.....	12
9. Clarification and Amendment of Bidding Documents .....	12
10. Documents Comprising the Bid: Eligibility and Technical Components .....	12
11. Documents Comprising the Bid: Financial Component .....	13
12. Alternative Bids .....	13
13. Bid Prices .....	13
14. Bid and Payment Currencies .....	13
15. Bid Security.....	14
16. Sealing and Marking of Bids.....	14
17. Deadline for Submission of Bids .....	14
18. Opening and Preliminary Examination of Bids .....	14
19. Detailed Evaluation and Comparison of Bids.....	14
20. Post Qualification.....	15
21. Signing of the Contract .....	15
<b>Section III. Bid Data Sheet .....</b>	<b>16</b>
<b>Section IV. General Conditions of Contract.....</b>	<b>17</b>
1. Scope of Contract.....	18
2. Sectional Completion of Works .....	18
3. Possession of Site.....	18
4. The Contractor's Obligations .....	18
5. Performance Security .....	18
6. Site Investigation Reports .....	19
7. Warranty.....	19
8. Liability of the Contractor.....	19
9. Termination for Other Causes .....	19
10. Dayworks .....	19
11. Program of Work.....	19

12. Instructions, Inspections and Audits .....	20
13. Advance Payment.....	20
14. Progress Payments .....	20
15. Operating and Maintenance Manuals.....	20
<b>Section V. Special Conditions of Contract .....</b>	<b>21</b>
<b>Section VI. Specifications .....</b>	<b>23</b>
<b>Section VII. Drawings .....</b>	<b>31</b>
<b>Section VIII. Bill of Quantities.....</b>	<b>32</b>
<b>Section IX. Checklist of Technical and Financial Documents .....</b>	<b>42</b>

# *Glossary of Terms, Abbreviations, and Acronyms*

**ABC** – Approved Budget for the Contract.

**ARCC** – Allowable Range of Contract Cost.

**BAC** – Bids and Awards Committee.

**Bid** – A signed offer or proposal to undertake a contract submitted by a bidder in response to and in consonance with the requirements of the bidding documents. Also referred to as *Proposal* and *Tender*. (2016 revised IRR, Section 5[c])

**Bidder** – Refers to a contractor, manufacturer, supplier, distributor and/or consultant who submits a bid in response to the requirements of the Bidding Documents. (2016 revised IRR, Section 5[d])

**Bidding Documents** – The documents issued by the Procuring Entity as the bases for bids, furnishing all information necessary for a prospective bidder to prepare a bid for the Goods, Infrastructure Projects, and/or Consulting Services required by the Procuring Entity. (2016 revised IRR, Section 5[e])

**BIR** – Bureau of Internal Revenue.

**BSP** – Bangko Sentral ng Pilipinas.

**CDA** – Cooperative Development Authority.

**Consulting Services** – Refer to services for Infrastructure Projects and other types of projects or activities of the GOP requiring adequate external technical and professional expertise that are beyond the capability and/or capacity of the GOP to undertake such as, but not limited to: (i) advisory and review services; (ii) pre-investment or feasibility studies; (iii) design; (iv) construction supervision; (v) management and related services; and (vi) other technical services or special studies. (2016 revised IRR, Section 5[i])

**Contract** – Refers to the agreement entered into between the Procuring Entity and the Supplier or Manufacturer or Distributor or Service Provider for procurement of Goods and Services; Contractor for Procurement of Infrastructure Projects; or Consultant or Consulting Firm for Procurement of Consulting Services; as the case may be, as recorded in the Contract Form signed by the parties, including all attachments and appendices thereto and all documents incorporated by reference therein.

**Contractor** – is a natural or juridical entity whose proposal was accepted by the Procuring Entity and to whom the Contract to execute the Work was awarded. Contractor as used in these Bidding Documents may likewise refer to a supplier, distributor, manufacturer, or consultant.

**CPI** – Consumer Price Index.

**DOLE** – Department of Labor and Employment.

**DTI** – Department of Trade and Industry.

**Foreign-funded Procurement or Foreign-Assisted Project** – Refers to procurement whose funding source is from a foreign government, foreign or international financing institution as specified in the Treaty or International or Executive Agreement. (2016 revised IRR, Section 5[b]).

**GFI** – Government Financial Institution.

**GOCC** – Government-owned and/or –controlled corporation.

**Goods** – Refer to all items, supplies, materials and general support services, except Consulting Services and Infrastructure Projects, which may be needed in the transaction of public businesses or in the pursuit of any government undertaking, project or activity, whether in the nature of equipment, furniture, stationery, materials for construction, or personal property of any kind, including non-personal or contractual services such as the repair and maintenance of equipment and furniture, as well as trucking, hauling, janitorial, security, and related or analogous services, as well as procurement of materials and supplies provided by the Procuring Entity for such services. The term “related” or “analogous services” shall include, but is not limited to, lease or purchase of office space, media advertisements, health maintenance services, and other services essential to the operation of the Procuring Entity. (2016 revised IRR, Section 5[r])

**GOP** – Government of the Philippines.

**Infrastructure Projects** – Include the construction, improvement, rehabilitation, demolition, repair, restoration or maintenance of roads and bridges, railways, airports, seaports, communication facilities, civil works components of information technology projects, irrigation, flood control and drainage, water supply, sanitation, sewerage and solid waste management systems, shore protection, energy/power and electrification facilities, national buildings, school buildings, hospital buildings, and other related construction projects of the government. Also referred to as *civil works or works*. (2016 revised IRR, Section 5[u])

**LGUs** – Local Government Units.

**NFCC** – Net Financial Contracting Capacity.

**NGA** – National Government Agency.

**PCAB** – Philippine Contractors Accreditation Board.

**PhilGEPS** - Philippine Government Electronic Procurement System.

**Procurement Project** – refers to a specific or identified procurement covering goods, infrastructure project or consulting services. A Procurement Project shall be described, detailed, and scheduled in the Project Procurement Management Plan prepared by the agency which shall be consolidated in the procuring entity's Annual Procurement Plan. (GPPB Circular No. 06-2019 dated 17 July 2019)

**PSA** – Philippine Statistics Authority.

**SEC** – Securities and Exchange Commission.

**SLCC** – Single Largest Completed Contract.

**UN** – United Nations.

## ***Section I. Invitation to Bid***





*Republic of the Philippines*  
*Province of Ilocos Norte*  
**CITY GOVERNMENT OF BATAC**

**Invitation to Bid for the CONSTRUCTION OF COVERED COURT  
AT BARANGAY MAIPALIG**

1. The *City Government of Batac*, through the *APPROPRIATION ORDINANCE 6SP 2024-01-SUPPLEMENTAL BUDGET NO. 01 CY 2024 – SPECIAL PURPOSE APPROPRIATION – 20% DEVELOPMENT FUND* intends to apply the sum of **Four Million Eight Hundred Fifty-one Thousand Two Hundred Eighty-six and Thirty-three Centavos (4,851,286.33)** being the Approved Budget for the Contract (ABC) to payments under the contract for **CONSTRUCTION OF COVERED COURT AT BARANGAY MAIPALIG** with *Project Identification Number: CGB-2025-PB-01-004*. Bids received in excess of the ABC shall be automatically rejected at bid opening.
2. The *City Government of Batac* now invites bids for the above Procurement Project. Completion of the Works is required **One Hundred Three (103) calendar days**. Bidders should have completed a contract similar to the Project. The description of an eligible bidder is contained in the Bidding Documents, particularly, in Section II (Instructions to Bidders).
3. Bidding will be conducted through open competitive bidding procedures using non-discretionary “*pass/fail*” criterion as specified in the 2016 revised Implementing Rules and Regulations (IRR) of Republic Act (RA) No. 9184.
4. Interested bidders may obtain further information from *City Government of Batac* and inspect the Bidding Documents at the address given below from **8:00am to 5:00pm**.
5. A complete set of Bidding Documents may be acquired by interested bidders on **January 07, 2025 (8:00AM to 5:00 PM) to January 27, 2025 (8:00 AM to 03:30 PM)** from given address and website/s below *and upon payment of the applicable fee for the Bidding Documents, pursuant to the latest Guidelines issued by the GPPB, in the amount of Php 5,000.00*. The Procuring Entity shall allow the bidder to present its proof of payment for the fees in person, by facsimile, or through electronic means.
6. The *City Government of Batac* will hold a Pre-Bid Conference<sup>1</sup> on **January 15, 2025 at 3:30** in the afternoon at the BAC Office, 3<sup>rd</sup> Floor City Hall Building, which shall be open to prospective bidders.
7. Bids must be duly received by the BAC Secretariat through manual submission at the office address as indicated below on or before **January 27, 2025 at 03:30 PM**. Late bids shall not be accepted.
8. All bids must be accompanied by a bid security in any of the acceptable forms and in the amount stated in **ITB** Clause 16.

---

<sup>1</sup> May be deleted in case the ABC is less than One Million Pesos (PhP1,000,000) where the Procuring Entity may not hold a pre-bid conference.

9. Bid opening shall be on **January 27, 2025** at BAC Office 3<sup>rd</sup> Floor City Hall Building. Bids will be opened in the presence of the or its authorized representatives (with his/her authorization) who choose to attend the activity.
10. The *City Government of Batac* reserves the right to reject any and all bids, declare a failure of bidding, or not award the contract at any time prior to contract award in accordance with Sections 35.6 and 41 of the 2016 revised Implementing Rules and Regulations (IRR) of RA No. 9184, without thereby incurring any liability to the affected bidder or bidders.
11. For further information, please refer to:

**ENGR. MICHELLE G. MANUEL**  
*BAC Secretariat Head - Infrastructure*  
*BAC Office 3<sup>rd</sup> Floor, City Hall Building*  
*City Government of Batac*  
*Washington Street, Brgy. #1-S Valdez*  
*City of Batac, Ilocos Norte 2906*  
*Email: [bacbataccity@gmail.com](mailto:bacbataccity@gmail.com)*  
*Tel.No.: (077) 670-6433*

12. You may visit the following websites:

For downloading of Bidding Documents: *you may visit [www.batac.gov.ph](http://www.batac.gov.ph)*

**MR. MARLON F. SORIA**  
*HRMO / BAC Chairman*

## ***Section II. Instructions to Bidders***

## 1. Scope of Bid

The Procuring Entity, *City Government of Batac* invites Bids for the ***Construction of Covered Court at Barangay Maipalig***, with ***Identification Number: CGB-2025-PB-01-004***.

The Procurement Project (“***Construction of Covered Court at Barangay Maipalig***”) is for the construction of Works, as described in Section VI (Specifications).

## 2. Funding Information

2.1. The GOP through the source of funding as indicated below in the amount of **Php 5,000,000.00**

2.2. The source of funding is: ***APPROPRIATION ORDINANCE 6SP 2024-01-SUPPLEMENTAL BUDGET NO. 01 CY 2024 – SPECIAL PURPOSE APPROPRIATION –20% DEVELOPMENT FUND***

2.3. Bidding Requirements

The Bidding for the Project shall be governed by all the provisions of RA No. 9184 and its 2016 revised IRR, including its Generic Procurement Manual and associated policies, rules and regulations as the primary source thereof, while the herein clauses shall serve as the secondary source thereof.

Any amendments made to the IRR and other GPPB issuances shall be applicable only to the ongoing posting, advertisement, or invitation to bid by the BAC through the issuance of a supplemental or bid bulletin.

The Bidder, by the act of submitting its Bid, shall be deemed to have inspected the site, determined the general characteristics of the contracted Works and the conditions for this Project, such as the location and the nature of the work; (b) climatic conditions; (c) transportation facilities; (c) nature and condition of the terrain, geological conditions at the site communication facilities, requirements, location and availability of construction aggregates and other materials, labor, water, electric power and access roads; and (d) other factors that may affect the cost, duration and execution or implementation of the contract, project, or work and examine all instructions, forms, terms, and project requirements in the Bidding Documents.

## 3. Corrupt, Fraudulent, Collusive, Coercive, and Obstructive Practices

The Procuring Entity, as well as the Bidders and Contractors, shall observe the highest standard of ethics during the procurement and execution of the contract. They or through an agent shall not engage in corrupt, fraudulent, collusive, coercive, and obstructive practices defined under Annex “I” of the 2016 revised IRR of RA No. 9184 or other integrity violations in competing for the Project.

## 4. Eligible Bidders

5.1. Only Bids of Bidders found to be legally, technically, and financially capable will be evaluated.

5.2. The Bidder must have an experience of having completed a Single Largest Completed Contract (SLCC) that is similar to this Project, equivalent to at least fifty percent (50%) of the ABC adjusted, if necessary, by the Bidder to current prices using the PSA’s CPI, except under conditions provided for in Section 23.4.2.4 of the 2016 revised IRR of RA No. 9184.

A contract is considered to be “similar” to the contract to be bid if it has the major categories of work stated in the **BDS**.

- 5.3. For Foreign-funded Procurement, the Procuring Entity and the foreign government/foreign or international financing institution may agree on another track record requirement, as specified in the Bidding Document prepared for this purpose.
- 5.4. The Bidders shall comply with the eligibility criteria under Section 23.4.2 of the 2016 IRR of RA No. 9184.

## **5. Origin of Associated Goods**

There is no restriction on the origin of Goods other than those prohibited by a decision of the UN Security Council taken under Chapter VII of the Charter of the UN.

## **6. Subcontracts**

- 7.1. The Bidder may subcontract portions of the Project to the extent allowed by the Procuring Entity as stated herein, but in no case more than fifty percent (50%) of the Project.

The Procuring Entity has prescribed that:

### **a. Subcontracting is not allowed**

## **7. Pre-Bid Conference**

The Procuring Entity will hold a pre-bid conference for this Project on **January 15, 2025** and/or through videoconferencing/webcasting as indicated in paragraph 6 of the **IB**.

## **9. Clarification and Amendment of Bidding Documents**

Prospective bidders may request for clarification on and/or interpretation of any part of the Bidding Documents. Such requests must be in writing and received by the Procuring Entity, either at its given address or through electronic mail indicated in the **IB**, at least ten (10) calendar days before the deadline set for the submission and receipt of Bids.

## **10. Documents Comprising the Bid: Eligibility and Technical Components**

- 10.1. The first envelope shall contain the eligibility and technical documents of the Bid as specified in **Section IX. Checklist of Technical and Financial Documents**.
- 10.2. If the eligibility requirements or statements, the bids, and all other documents for submission to the BAC are in foreign language other than English, it must be accompanied by a translation in English, which shall be authenticated by the appropriate Philippine foreign service establishment, post, or the equivalent office having jurisdiction over the foreign bidder’s affairs in the Philippines. For Contracting Parties to the Apostille Convention, only the translated documents shall be authenticated through an apostille pursuant to GPPB Resolution No. 13-2019 dated 23 May 2019. The English translation shall govern, for purposes of interpretation of the bid.

- 10.3. A valid PCAB License is required, and in case of joint ventures, a valid special PCAB License, and registration for the type and cost of the contract for this Project. Any additional type of Contractor license or permit shall be indicated in the **BDS**.
- 10.4. A List of Contractor's key personnel (e.g., Project Manager, Project Engineers, Materials Engineers, and Foremen) assigned to the contract to be bid, with their complete qualification and experience data shall be provided. These key personnel must meet the required minimum years of experience set in the **BDS**.
- 10.5. A List of Contractor's major equipment units, which are owned, leased, and/or under purchase agreements, supported by proof of ownership, certification of availability of equipment from the equipment lessor/vendor for the duration of the project, as the case may be, must meet the minimum requirements for the contract set in the **BDS**.

## **11. Documents Comprising the Bid: Financial Component**

- 11.1. The second bid envelope shall contain the financial documents for the Bid as specified in **Section IX. Checklist of Technical and Financial Documents**.
- 11.2. Any bid exceeding the ABC indicated in paragraph 1 of the **IB** shall not be accepted.
- 11.3. For Foreign-funded procurement, a ceiling may be applied to bid prices provided the conditions are met under Section 31.2 of the 2016 revised IRR of RA No. 9184.

## **12. Alternative Bids**

Bidders shall submit offers that comply with the requirements of the Bidding Documents, including the basic technical design as indicated in the drawings and specifications. Unless there is a value engineering clause in the **BDS**, alternative Bids shall not be accepted.

## **13. Bid Prices**

All bid prices for the given scope of work in the Project as awarded shall be considered as fixed prices, and therefore not subject to price escalation during contract implementation, except under extraordinary circumstances as determined by the NEDA and approved by the GPPB pursuant to the revised Guidelines for Contract Price Escalation guidelines.

## **14. Bid and Payment Currencies**

- 14.1. Bid prices may be quoted in the local currency or tradeable currency accepted by the BSP at the discretion of the Bidder. However, for purposes of bid evaluation, Bids denominated in foreign currencies shall be converted to Philippine currency based on the exchange rate as published in the BSP reference rate bulletin on the day of the bid opening.
- 14.2. *Payment of the contract price shall be made in:*
  - a. Philippine Pesos.

## 15. Bid Security

- 15.1. The Bidder shall submit a Bid Securing Declaration or any form of Bid Security in the amount indicated in the **BDS**, which shall be not less than the percentage of the ABC in accordance with the schedule in the **BDS**.
- 15.2. The Bid and bid security shall be valid until *120 days*. Any bid not accompanied by an acceptable bid security shall be rejected by the Procuring Entity as non-responsive.

## 16. Sealing and Marking of Bids

Each Bidder shall submit one copy of the first and second components of its Bid.

The Procuring Entity may request additional hard copies and/or electronic copies of the Bid. However, failure of the Bidders to comply with the said request shall not be a ground for disqualification.

If the Procuring Entity allows the submission of bids through online submission to the given website or any other electronic means, the Bidder shall submit an electronic copy of its Bid, which must be digitally signed. An electronic copy that cannot be opened or is corrupted shall be considered non-responsive and, thus, automatically disqualified.

## 17. Deadline for Submission of Bids

The Bidders shall submit on the specified date and time and either at its physical address or through online submission as indicated in paragraph 7 of the **IB**.

## 18. Opening and Preliminary Examination of Bids

- 18.1. The BAC shall open the Bids in public at the time, on the date, and at the place specified in paragraph 9 of the **IB**. The Bidders' representatives who are present shall sign a register evidencing their attendance. In case videoconferencing, webcasting or other similar technologies will be used, attendance of participants shall likewise be recorded by the BAC Secretariat.

In case the Bids cannot be opened as scheduled due to justifiable reasons, the rescheduling requirements under Section 29 of the 2016 revised IRR of RA No. 9184 shall prevail.

- 18.2. The preliminary examination of Bids shall be governed by Section 30 of the 2016 revised IRR of RA No. 9184.

## 19. Detailed Evaluation and Comparison of Bids

- 19.1. The Procuring Entity's BAC shall immediately conduct a detailed evaluation of all Bids rated "*passed*" using non-discretionary pass/fail criteria. The BAC shall consider the conditions in the evaluation of Bids under Section 32.2 of 2016 revised IRR of RA No. 9184.
- 19.2. If the Project allows partial bids, all Bids and combinations of Bids as indicated in the **BDS** shall be received by the same deadline and opened and evaluated simultaneously so as to determine the Bid or combination of Bids offering the lowest calculated cost to the Procuring Entity. Bid Security as required by **ITB** Clause 15 shall be submitted for each contract (lot) separately.

- 19.3. In all cases, the NFCC computation pursuant to Section 23.4.2.6 of the 2016 revised IRR of RA No. 9184 must be sufficient for the total of the ABCs for all the lots participated in by the prospective Bidder.

## **20. Post Qualification**

Within a non-extendible period of five (5) calendar days from receipt by the Bidder of the notice from the BAC that it submitted the Lowest Calculated Bid, the Bidder shall submit its latest income and business tax returns filed and paid through the BIR Electronic Filing and Payment System (eFPS), and other appropriate licenses and permits required by law and stated in the **BDS**.

## **21. Signing of the Contract**

The documents required in Section 37.2 of the 2016 revised IRR of RA No. 9184 shall form part of the Contract. Additional Contract documents are indicated in the **BDS**.



## *Section III. Bid Data Sheet*

### **Bid Data Sheet**

<b>ITB Clause</b>																																		
5.2	For this purpose, contracts similar to the Project refer to contracts which have the same major categories of work, which shall be: <i>Plain and reinforced concrete works and Roof framing and Roofing works.</i>																																	
7.1	<i>Sub-contracting is not allowed.</i>																																	
10.3	<i>None</i>																																	
10.4	The key personnel must meet the required minimum years of experience set below:																																	
	<table border="1" style="width: 100%; border-collapse: collapse;"> <thead> <tr> <th style="text-align: left;"><u>Key Personnel</u></th> <th style="text-align: left;"><u>General Experience</u></th> <th style="text-align: left;"><u>Relevant Experience</u></th> </tr> </thead> <tbody> <tr> <td>Project Engineer</td> <td>General Construction</td> <td>5 years</td> </tr> <tr> <td>Materials Engineer</td> <td>General Construction</td> <td>1 year</td> </tr> <tr> <td>Construction Foreman</td> <td>General Construction</td> <td>5 years</td> </tr> <tr> <td>Skilled Worker</td> <td>General Construction</td> <td>5 years</td> </tr> <tr> <td>Unskilled Laborer</td> <td>General Construction</td> <td>3 years</td> </tr> <tr> <td>Safety Officer II</td> <td>General Construction</td> <td>1 year</td> </tr> </tbody> </table>	<u>Key Personnel</u>	<u>General Experience</u>	<u>Relevant Experience</u>	Project Engineer	General Construction	5 years	Materials Engineer	General Construction	1 year	Construction Foreman	General Construction	5 years	Skilled Worker	General Construction	5 years	Unskilled Laborer	General Construction	3 years	Safety Officer II	General Construction	1 year												
<u>Key Personnel</u>	<u>General Experience</u>	<u>Relevant Experience</u>																																
Project Engineer	General Construction	5 years																																
Materials Engineer	General Construction	1 year																																
Construction Foreman	General Construction	5 years																																
Skilled Worker	General Construction	5 years																																
Unskilled Laborer	General Construction	3 years																																
Safety Officer II	General Construction	1 year																																
10.5	The minimum major equipment requirements are the following:																																	
	<table border="1" style="width: 100%; border-collapse: collapse;"> <thead> <tr> <th style="text-align: left;"><u>Equipment</u></th> <th style="text-align: left;"><u>Capacity</u></th> <th style="text-align: left;"><u>Number of Units</u></th> </tr> </thead> <tbody> <tr> <td>Plate Compactor</td> <td>5hp</td> <td>1</td> </tr> <tr> <td>One Bagger Mixer</td> <td></td> <td>1</td> </tr> <tr> <td>Bar Cutter</td> <td>Single Phase</td> <td>1</td> </tr> <tr> <td>Welding Machine</td> <td>500 Amp</td> <td>1</td> </tr> <tr> <td>Oxygen/Acetylene Cutter</td> <td></td> <td>1</td> </tr> <tr> <td>Cutting Outfit</td> <td></td> <td>1</td> </tr> <tr> <td>Concrete Chipper/Jack Hammer</td> <td></td> <td>1</td> </tr> <tr> <td>Back hoe</td> <td>0.80 cu.m.</td> <td>1</td> </tr> <tr> <td>Dump Truck</td> <td>12 cu.yd.</td> <td>1</td> </tr> <tr> <td>Concrete Vibrator</td> <td></td> <td>1</td> </tr> </tbody> </table>	<u>Equipment</u>	<u>Capacity</u>	<u>Number of Units</u>	Plate Compactor	5hp	1	One Bagger Mixer		1	Bar Cutter	Single Phase	1	Welding Machine	500 Amp	1	Oxygen/Acetylene Cutter		1	Cutting Outfit		1	Concrete Chipper/Jack Hammer		1	Back hoe	0.80 cu.m.	1	Dump Truck	12 cu.yd.	1	Concrete Vibrator		1
<u>Equipment</u>	<u>Capacity</u>	<u>Number of Units</u>																																
Plate Compactor	5hp	1																																
One Bagger Mixer		1																																
Bar Cutter	Single Phase	1																																
Welding Machine	500 Amp	1																																
Oxygen/Acetylene Cutter		1																																
Cutting Outfit		1																																
Concrete Chipper/Jack Hammer		1																																
Back hoe	0.80 cu.m.	1																																
Dump Truck	12 cu.yd.	1																																
Concrete Vibrator		1																																
12	<i>Value Engineering not allowed.</i>																																	
15.1	The bid security shall be in the form of a Bid Securing Declaration or any of the following forms and amounts: <ul style="list-style-type: none"> <li>a. The amount of not less than 97,025.7266, if bid security is in cash, cashier's/manager's check, bank draft/guarantee or irrevocable letter of credit;</li> <li>b. The amount of not less than 242,564.3165, if bid security is in Surety Bond.</li> </ul>																																	
19.2	Partial bids are not allowed.																																	
20	<i>None</i>																																	
21	Additional contract documents relevant to the Project that may be required by existing laws and/or the Procuring Entity, such as construction schedule and S-curve, manpower schedule, construction methods, equipment utilization schedule, construction safety and health program approved by the DOLE, and other acceptable tools of project scheduling.																																	

## ***Section IV. General Conditions of Contract***

## 1. **Scope of Contract**

This Contract shall include all such items, although not specifically mentioned, that can be reasonably inferred as being required for its completion as if such items were expressly mentioned herein. All the provisions of RA No. 9184 and its 2016 revised IRR, including the Generic Procurement Manual, and associated issuances, constitute the primary source for the terms and conditions of the Contract, and thus, applicable in contract implementation. Herein clauses shall serve as the secondary source for the terms and conditions of the Contract.

This is without prejudice to Sections 74.1 and 74.2 of the 2016 revised IRR of RA No. 9184 allowing the GPPB to amend the IRR, which shall be applied to all procurement activities, the advertisement, posting, or invitation of which were issued after the effectivity of the said amendment.

## 2. **Sectional Completion of Works**

If sectional completion is specified in the **Special Conditions of Contract (SCC)**, references in the Conditions of Contract to the Works, the Completion Date, and the Intended Completion Date shall apply to any Section of the Works (other than references to the Completion Date and Intended Completion Date for the whole of the Works).

## 3. **Possession of Site**

3.1 The Procuring Entity shall give possession of all or parts of the Site to the Contractor based on the schedule of delivery indicated in the **SCC**, which corresponds to the execution of the Works. If the Contractor suffers delay or incurs cost from failure on the part of the Procuring Entity to give possession in accordance with the terms of this clause, the Procuring Entity's Representative shall give the Contractor a Contract Time Extension and certify such sum as fair to cover the cost incurred, which sum shall be paid by Procuring Entity.

3.2 If possession of a portion is not given by the above date, the Procuring Entity will be deemed to have delayed the start of the relevant activities. The resulting adjustments in contract time to address such delay may be addressed through contract extension provided under Annex "E" of the 2016 revised IRR of RA No. 9184.

## 4. **The Contractor's Obligations**

The Contractor shall employ the key personnel named in the Schedule of Key Personnel indicating their designation, in accordance with **ITB** Clause 10.3 and specified in the **BDS**, to carry out the supervision of the Works.

The Procuring Entity will approve any proposed replacement of key personnel only if their relevant qualifications and abilities are equal to or better than those of the personnel listed in the Schedule.

## 5. **Performance Security**

5.1. Within ten (10) calendar days from receipt of the Notice of Award from the Procuring Entity but in no case later than the signing of the contract by both parties, the successful Bidder shall furnish the performance security in any of the forms prescribed in Section 39 of the 2016 revised IRR.

- 5.2. The Contractor, by entering into the Contract with the Procuring Entity, acknowledges the right of the Procuring Entity to institute action pursuant to RA No. 3688 against any subcontractor be they an individual, firm, partnership, corporation, or association supplying the Contractor with labor, materials and/or equipment for the performance of this Contract.

## **6. Site Investigation Reports**

The Contractor, in preparing the Bid, shall rely on any Site Investigation Reports referred to in the **SCC** supplemented by any information obtained by the Contractor.

## **7. Warranty**

- 7.1. In case the Contractor fails to undertake the repair works under Section 62.2.2 of the 2016 revised IRR, the Procuring Entity shall forfeit its performance security, subject its property(ies) to attachment or garnishment proceedings, and perpetually disqualify it from participating in any public bidding. All payables of the GOP in his favor shall be offset to recover the costs.
- 7.2. The warranty against Structural Defects/Failures, except that occasioned-on force majeure, shall cover the period from the date of issuance of the Certificate of Final Acceptance by the Procuring Entity. Specific duration of the warranty is found in the **SCC**.

## **8. Liability of the Contractor**

Subject to additional provisions, if any, set forth in the **SCC**, the Contractor's liability under this Contract shall be as provided by the laws of the Republic of the Philippines.

If the Contractor is a joint venture, all partners to the joint venture shall be jointly and severally liable to the Procuring Entity.

## **9. Termination for Other Causes**

Contract termination shall be initiated in case it is determined *prima facie* by the Procuring Entity that the Contractor has engaged, before, or during the implementation of the contract, in unlawful deeds and behaviors relative to contract acquisition and implementation, such as, but not limited to corrupt, fraudulent, collusive, coercive, and obstructive practices as stated in **ITB** Clause 4.

## **10. Dayworks**

Subject to the guidelines on Variation Order in Annex "E" of the 2016 revised IRR of RA No. 9184, and if applicable as indicated in the **SCC**, the Dayworks rates in the Contractor's Bid shall be used for small additional amounts of work only when the Procuring Entity's Representative has given written instructions in advance for additional work to be paid for in that way.

## **11. Program of Work**

- 11.1. The Contractor shall submit to the Procuring Entity's Representative for approval the said Program of Work showing the general methods, arrangements, order, and timing for all the activities in the Works. The submissions of the Program of Work are indicated in the **SCC**.
- 11.2. The Contractor shall submit to the Procuring Entity's Representative for approval an updated Program of Work at intervals no longer than the period stated in the **SCC**. If the Contractor does not submit an updated Program of Work within this period, the Procuring Entity's Representative may withhold

the amount stated in the **SCC** from the next payment certificate and continue to withhold this amount until the next payment after the date on which the overdue Program of Work has been submitted.

## **12. Instructions, Inspections and Audits**

The Contractor shall permit the GOP or the Procuring Entity to inspect the Contractor's accounts and records relating to the performance of the Contractor and to have them audited by auditors of the GOP or the Procuring Entity, as may be required.

## **13. Advance Payment**

The Procuring Entity shall, upon a written request of the Contractor which shall be submitted as a Contract document, make an advance payment to the Contractor in an amount not exceeding fifteen percent (15%) of the total contract price, to be made in lump sum, or at the most two installments according to a schedule specified in the **SCC**, subject to the requirements in Annex "E" of the 2016 revised IRR of RA No. 9184.

## **14. Progress Payments**

The Contractor may submit a request for payment for Work accomplished. Such requests for payment shall be verified and certified by the Procuring Entity's Representative/Project Engineer. Except as otherwise stipulated in the **SCC**, materials and equipment delivered on the site but not completely put in place shall not be included for payment.

## **15. Operating and Maintenance Manuals**

- 15.1. If required, the Contractor will provide "as built" Drawings and/or operating and maintenance manuals as specified in the **SCC**.
- 15.2. If the Contractor does not provide the Drawings and/or manuals by the dates stated above, or they do not receive the Procuring Entity's Representative's approval, the Procuring Entity's Representative may withhold the amount stated in the **SCC** from payments due to the Contractor.

## *Section V. Special Conditions of Contract*

# Special Conditions of Contract

GCC Clause	
2	<i>The intended completion date is <b>One hundred three (103) calendar days from the Effective Date of the Contract.</b></i>
4.1	N/A
6	N/A
7.2	Five (5) years.
10	Dayworks are applicable at the rate shown in the Contractor's original Bid.
11.1	The Contractor shall submit the Program of Work to the Procuring Entity's Representative within <b>Seven (7)</b> days of delivery of the Notice of Award.
11.2	N/A
13	The amount of the advance payment <b><i>shall not exceed 15% of the total contract price and schedule of payment.</i></b>
14	<i>Not Allowed</i>
15.1	N/A
15.2	N/A

## *Section VI. Specifications*



## **SECTION VI. SPECIFICATIONS**

### **GENERAL SPECIFICATIONS FOR THE CONSTRUCTION OF:**

Project : **CONSTRUCTION OF COVERED COURT AT BARANGAY MAZPALIG**  
Location : **Brgy. #22 Mazpalig, City of Batac, Ilocos Norte**

#### **A. SCOPE OF WORK:**

1. The work contemplated under this contract consist of:
  - a) Furnishing all necessary materials, labor and tools for the construction of the project in accordance with the plans and specifications unless otherwise specified.

#### **B. PLANS AND SPECIFICATIONS:**

1. The plans and specifications shall be considered as cooperatives and all labor materials in one and not mentioned or indicated in other or vice versa and shall not be done by the contractor as if these are duly mentioned in both.
2. If so, numerical indications appear in the plans, all drawings shall be careful follow according to the scale of the drawing, but if they are not indicated, the numerical rotations must be followed and not the scale of the drawing and specifications, specifications shall govern. In case of discrepancies of the figures or drawings the matter shall be immediately submitted to the project-in-charge before any adjustments shall be made.
3. The owner, contractor or workmen without prior agreement or approval, no changes in the drawing and specifications shall be made.

#### **C. PREPARATION OF THE SITE**

##### **C.a. - Workmanship**

Site must be properly secured and barricaded in accordance with the Safety and Health procedures. Materials to be delivered at the site must be properly warehoused.

#### **D. EXCAVATION AND BACKFILLING**

##### **D.a. - Scope of Work**

Filling and backfilling are necessary to bring elevations to finished levels, including furnishing of extra filling materials required.

D.b. - Materials to be of earth or any other materials is free from soft lumps of clay.

D.c. - Where footings and/or foundation occur, use concrete fill for some proportions as specified for footing foundations.

D.d. - Where slabs occur, use well compacted earth fill.

## E. CONCRETE WORKS

### E.a. – Materials

1. Portland Cement: Philippine manufactured conforming to the standard specifications and test for Portland Cement of the AMERICAN SOCIETY FOR TESTING MATERIALS (ASTM) and subsequent revisions thereof.
2. Concrete Aggregates: River gravel, having clean, hard, strong, and durable uncoated particles.
3. Fire aggregates: Sand with similar characteristics, having clean, hard, strong, and durable grains.
4. Water: Water for concrete shall be clean and free from injurious amount of oil, acid, and other deleterious substances, fit for drinking.
5. Concrete for footings, columns and beams shall be Class "A" or 1:2:4 mix.
6. Concrete on slabs on fill shall be class "C" or 1:3:6 mix.

### E.b. - Workmanship

All concrete works shall be done in accordance with the specifications for concrete and reinforcements as adopted by the Department of Public Works and Highways.

## F. REINFORCING STEEL BARS

### F.a. - Materials

Metal reinforcements - Conforms to all the requirements of the standard specifications of the billet steel concrete reinforcement bars of the intermediate grade.

### F.b. – Workmanship

Accurately positioned and unless otherwise specified, shall be secured against displacement by using at intersections Ga. 16 G.I tie wire.

### F.c. - Please refer to attached manufacturer's specifications for Structural Decking Works.

## G. MORTAR

All mortars for cement plaster shall be 1:2 mix, one (1) part cement and two (2) parts sand by volume.

## H. CONCRETE HOLLOW BLOCKS

### H.a. – Materials

Concrete hollow blocks shall be those available in the locality fit for construction, true to size without imperfections or defects which may impair their strength and durability.

### H.b. – Workmanship

1. At the time of the pouring of concrete for the foundation or footing, the first blocks shall be laid and grouted in the wet concrete setting at least one-half (½) of the blocks into the wet mixture. The first course shall be carefully levelled and lined as it is laid. Blocks are then laid above the first course in staggered fashion. Vertical reinforcements shall extend to the footing. All concrete hollow blocks shall be laid with cement mortar 1:3 mix.

2. Concrete hollow blocks wall shall be applied with 20 millimeter thick cement plaster finish on the interior and the exterior. Other wall finishes shall be in accordance with the plans and specifications.

3. Concrete hollow blocks shall be soaked one-half (½) hour before plastering and be damped when plastering is done. After the application of the plaster, the plastered walls shall be always kept damped for a period of three(3) days.

#### L. CARPENTRY AND JOINERY WORKS

##### L.a. - Materials

1. Lumber to be used shall be of the approved quality of the respective kinds required for the various parts of the work; well-seasoned, thoroughly dry and free from all kinds of imperfections.
2. All wood frameworks and other members in contact with concrete shall be anchored with 70 mm C.W. nails all around with the contact surfaces.
3. All exposed nails shall be countersinking.

#### J. ROOFING

##### J.a. - Materials

1. Pre-painted Rib-type panel for roofing panels. The materials specifications shall be as follows:

Base metal thickness	: 0.500 mm
Feed width	: 1.032 mm
Zinc coating	: 215 g/sq. m.
Effective coverage	: 1000 mm
Side lapping	: one and a half (1½)

2. All ridge rolls, flashings, gutters and downspouts shall be .500 mm thick pre-painted.

##### J.b. - Workmanship

1. All roofing sheets, ridge rolls, flashings, gutters and downspouts shall be installed according to the manufacturer's specifications. Laying should start from the end opposite the side from where the monsoon wind is coming from. Lay and install the first sheet with the turned-down edge towards the outside of the area to be covered. Overlap the next sheet to the previous sheet in such a manner that the exposed edge is turned down.
2. The pitch of the roofs should be a minimum of 10% or 1 in 10. Best results can be obtained if the top of the purlins are in one plain, in as much as the sheets come in eave to ridge lengths. All installations shall be free from leaks.
3. To secure a sound and permanent roof with maximum economy, the roof plan should be made as simple as possible. Purlins should be spaced as required or as per manufacturer's specifications with top surface at a common level so that sheets are resting on them evenly.
4. The sheets shall be fastened to the purlins by means of mounting screws or as per manufacturer's specifications.

#### K. PLUMBING

##### K.a. - General

1. All works included in this section shall be suited to the general conditions of the entire operation.
2. Labor shall include complete installation of the plumbing system including all fixtures.

#### K.b. - Materials

1. The contractor shall with the designer's approval secure all materials and fixtures that will be used in connection with the work.
2. Water supply pipes and fittings shall be Galvanized Iron, Schedule 40, of dimensions as indicated in the plans.
3. Sanitary pipes shall be Polyvinyl Chloride. For pipe sizes below 100 mm in diameter, use Series 1000 and Class 34 for sizes equal and above 100 mm in diameter.
4. Vent pipes shall be 50 mm in diameter ordinary Polyvinyl chloride pipes.
5. Plumbing fixtures shall conform with the manufacturer's specifications with the design and color to be approved by the designer.

#### K.c. - Workmanship

1. All plumbing works shall be in accordance with the rules and regulations of the Philippine Plumbing Code, executed in the best manner and according to standard practices.
2. All pipings and waste shall be embedded in the concrete and masonry works or concealed between partitions. Water tests shall be made before embedding or covering the system.
3. All fixtures shall be installed complete with accessories, such as tank fittings, angle valve, shut-off valve, P-trap, etc.
4. Provisions of the following special fittings:
  - a. Valves - Gate valves shall be clamp gate type with iron body and brass trim.
  - b. Unions - Unions shall be placed near valves and whenever necessary to facilitate removal of pipes, valve and equipment.
  - c. Clean-outs - Sufficient clean-outs with screw caps shall be provided for easy cleaning of the whole system.
  - d. Vent - Vent pipes shall be extended fully well above the highest fixture serviced.

#### L. ELECTRICAL WORKS

##### L.a. - General

The works consists of furnishing of all materials, labor, tools and equipment and performing all operations in connection with the electrical system as shown on the drawings and conforming with the latest edition of the PHILIPPINE ELECTRICAL CODE, the rules and regulations of the locality and all other works which are necessary to bring the electrical system to operating condition and ready for use by the end-user.

L.b. - Materials

1. All switch plates shall be standard with bakelite cover.
2. All convenience outlets shall be flush duplex type and provide with bakelite cover.
3. All electrical conduits fittings shall be smooth walled UPVC as approved by the BUREAU OF PRODUCTS STANDARDS and accepted for use by the PHILIPPINE ELECTRICAL CODE.
4. Sizes and type of wirings shall be as plan and specifications.
5. Wirings for convenience outlets shall be 3.5 mm<sup>2</sup> THHN unless otherwise specified.
6. Circuit breakers shall be quick make, quick break thermal magnetic trip-indicating and have common trip on all multiple breaker with internal tie mechanism.

L.c. -Workmanship

The scope of the work shall include the following:

1. the complete lighting and power system from the connection including all outlets, devices, convenience receptacles and switches.
2. All circuit breakers, main panel and other power supplies indicated in the plans and specifications.

All wiring placed underground or embedded in concrete or masonry and passing thru partitions shall use UPVC conduits with type THHN wires as conductors unless indicated otherwise and shall terminate at proper boxes and fittings.

The pipes and fittings shall be homogeneous throughout and free from visible cracks, holes and other injurious defects. The inside surfaces shall be smooth for the pulling-in of electrical wires and cables. The pipes shall be uniform in color. The ends shall be clearly cut and square with the axis of the pipe.

M. STEEL WORKS

M.a. - General

The works consist of the furnishing of all materials, labor, tools and equipment necessary in the fabrication, erection and installation required to complete all structural steel works indicated in the plans and specifications including cleaning and painting.

M.b. - Materials

1. All Structural Steel shapes, plates, rolled and built-up sections shall be ASTM A-36. All Cold Formed Light Gauge Steel Sections shall be ASTM A-245. All arc-welding Electrodes shall be ASTM A-233, E 60 xx or E 70xx.
2. Use angle bars for top and bottom chords, including web members; use light weight C purlins as shown in the plans and as indicated in the specifications.
3. Use mild steel Gusset plates for angle bars joints and all other joints, and all joints shall be fully weld as indicated in the drawings.

M.c. – Workmanship

1. Workmanship, erection, fabrication and all installation shall be in accordance with the latest edition of AISC Specifications for Fabrication and Erection of Structural Steel.

2. All welded sections shall develop full strength of the members. The technique of welding employed, appearance and quality for welds made and the method of correcting defective work shall conform to the American Welding Society, Code for Arch-Welding in Building Construction, Section 4, Workmanship.

3. Surfaces to be welded shall be free from loose scale, rust, grease, paint and other foreign materials except that mill scale which withstands vigorous wire brushing may remain. Join surfaces shall be free from fins and tears. Finished members shall be true to line and free from twists, bends and open joints.

4. All painting works shall be done on dry surfaces, free from rust, scale and grease. Steel shall be flame cleaned in the shop to remove mill scale. Surfaces in contact shall be cleaned by effective means but not painted except that contact surfaces of exposed exterior steel shall be painted. All steel surfaces shall receive one coat of primer.

#### N. PAINTING WORKS

##### N.a. – General

This work includes interior and exterior painting and varnishing and finishing of all items as required to produce a finished painting job throughout all the areas affected by the work under this contract, except items which is specifically excluded.

All exposed sections shall be protected while the building is being painted or varnished.

##### N.b. – Preparation of Surface

1. All new concrete shall be allowed to weather for at least two months, or moisture proofed by applying with neutralizer if painted earlier than the weathering period.

2. All new G.I. sheets to be painted shall be applied with Galvawash to remove grease, oil and other surface contaminants before applying primer.

3. All metal surfaces shall be cleaned free of mold seals, rust and foreign matter. Grease shall be scraped with wire brush to sound metal dust.

4. All other surfaces to be painted or varnished shall be cleaned of loose dirt and dust before painting and varnishing.

5. Wood doors, door jambs and cabinets shall be pulled and seal sprayed with automotive lacquer spray.

6. Except as otherwise specified, all paints shall be applied in three (3) coatings. Applications shall be by roller or brush or as per manufacture's specifications and each coating shall be allowed to dry before applying succeeding coatings.

#### O. FINISHING WORKS

O.a. - All floor finishes shall be in accordance with the plans and specifications.

O.b. – Exterior and interior wall finishes shall be plain cement finish, except as indicated in the plans and specifications.

O.c. – Brick tile veneer shall be as shown in the drawings.

1. All exposed sections shall be protected while the building is being painted or varnished.

#### P. STONE MASONRY

##### P.a. – General

This item shall consist of stone masonry in minor structures, in headwalls for culverts, in retaining walls at the toes of slopes, and at other places called for in the plans, constructed on the prepared foundation bed, in accordance with this specification and in conformity with the lines, grades, sections, and dimensions shown on the plans or as ordered in writing by the Engineer.

##### P.b. – Material Requirements

1. Stone – the stone shall be clean, hard, and durable and shall be subject to the Engineer's approval. Adobe stone shall not be used unless otherwise specified.

Sizes and Shapes – unless other sizes are shown on the plans, stones have a thickness of not less than 150mm, and widths of not less than one and one-half times their respective widths. Each stone shall be of good shape and be free of depressions and projections that might weaken or prevent it from being properly bedded.

Dressing- the stone shall be dressed to remove any thin or weak portions. Face stones shall be dressed to provide bed and joint lines that do not vary more than 20mm from the true lines and to ensure the meeting of bed and joint lines without the rounding of corners of the stones in excess of 30mm in radius. Be surfaces of the stones shall be approximately normal to the face of the stones for about 80mm and from this point may depart from a normal plane not to exceed 50 mm in 300 mm.

Finished for Exposed Faces – face stones shall be pitched to the line along the beds and joints. The maximum projection of rock faces beyond the pitch lines shall not be more than 50 mm

2. Mortar - Cement, fine aggregate, and water shall conform to the respective requirements for those materials as specified under item 405, structural concrete except as to the grading of fine aggregate which shall all pass the n0. 8 sieves, not less than 15 nor more than 40 percent shall pass the no. 50 sieve, not more than 10 percent shall pass the no.100 sieve.
3. Weepholes - All walls and abutments shall be provided with weepholes. Unless otherwise shown on the plans or directed by the engineer. The weepholes shall be placed horizontally and at the lowest points where free outlets for water can be obtained and shall be spaced at not more than 2m center to center in a staggered manner. The length of the weepholes shall not be less than the thickness of the walls of the abutment and shall be at least 50 m in diameter PVC or other pipe materials accepted by the engineer. Weepholes must be provided with filter bags as the specified provision or as directed by the engineer and shall be incidental to pay item 505.

Prepared by:

  
**ZHERLAND P. REBUCAL**  
Engineer II

P7

## *Section VII. Drawings*



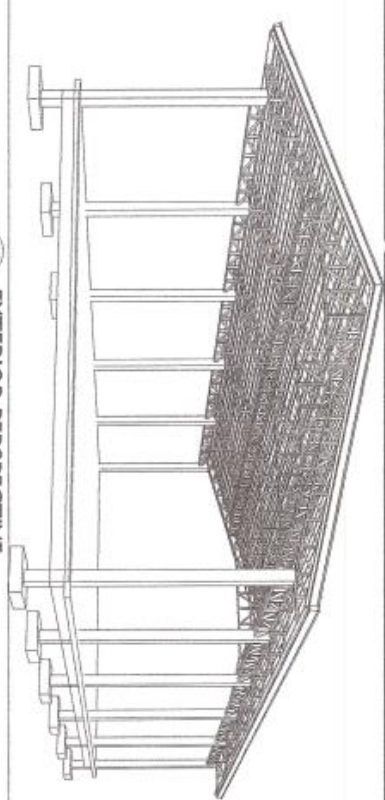

1 EXTERIOR PERSPECTIVE  
SCALE A:1

LOT 59130

Area	Lot Area	Area	Lot Area	Area	Lot Area
1	1,000.00	2	1,000.00	3	1,000.00
4	1,000.00	5	1,000.00	6	1,000.00
7	1,000.00	8	1,000.00	9	1,000.00
10	1,000.00	11	1,000.00	12	1,000.00
13	1,000.00	14	1,000.00	15	1,000.00
16	1,000.00	17	1,000.00	18	1,000.00
19	1,000.00	20	1,000.00	21	1,000.00
22	1,000.00	23	1,000.00	24	1,000.00
25	1,000.00	26	1,000.00	27	1,000.00
28	1,000.00	29	1,000.00	30	1,000.00
31	1,000.00	32	1,000.00	33	1,000.00
34	1,000.00	35	1,000.00	36	1,000.00
37	1,000.00	38	1,000.00	39	1,000.00
40	1,000.00	41	1,000.00	42	1,000.00
43	1,000.00	44	1,000.00	45	1,000.00
46	1,000.00	47	1,000.00	48	1,000.00
49	1,000.00	50	1,000.00	51	1,000.00
52	1,000.00	53	1,000.00	54	1,000.00
55	1,000.00	56	1,000.00	57	1,000.00
58	1,000.00	59	1,000.00	60	1,000.00
61	1,000.00	62	1,000.00	63	1,000.00
64	1,000.00	65	1,000.00	66	1,000.00
67	1,000.00	68	1,000.00	69	1,000.00
70	1,000.00	71	1,000.00	72	1,000.00
73	1,000.00	74	1,000.00	75	1,000.00
76	1,000.00	77	1,000.00	78	1,000.00
79	1,000.00	80	1,000.00	81	1,000.00
82	1,000.00	83	1,000.00	84	1,000.00
85	1,000.00	86	1,000.00	87	1,000.00
88	1,000.00	89	1,000.00	90	1,000.00
91	1,000.00	92	1,000.00	93	1,000.00
94	1,000.00	95	1,000.00	96	1,000.00
97	1,000.00	98	1,000.00	99	1,000.00
100	1,000.00	101	1,000.00	102	1,000.00
103	1,000.00	104	1,000.00	105	1,000.00
106	1,000.00	107	1,000.00	108	1,000.00
109	1,000.00	110	1,000.00	111	1,000.00
112	1,000.00	113	1,000.00	114	1,000.00
115	1,000.00	116	1,000.00	117	1,000.00
118	1,000.00	119	1,000.00	120	1,000.00
121	1,000.00	122	1,000.00	123	1,000.00
124	1,000.00	125	1,000.00	126	1,000.00
127	1,000.00	128	1,000.00	129	1,000.00
130	1,000.00	131	1,000.00	132	1,000.00
133	1,000.00	134	1,000.00	135	1,000.00
136	1,000.00	137	1,000.00	138	1,000.00
139	1,000.00	140	1,000.00	141	1,000.00
142	1,000.00	143	1,000.00	144	1,000.00
145	1,000.00	146	1,000.00	147	1,000.00
148	1,000.00	149	1,000.00	150	1,000.00

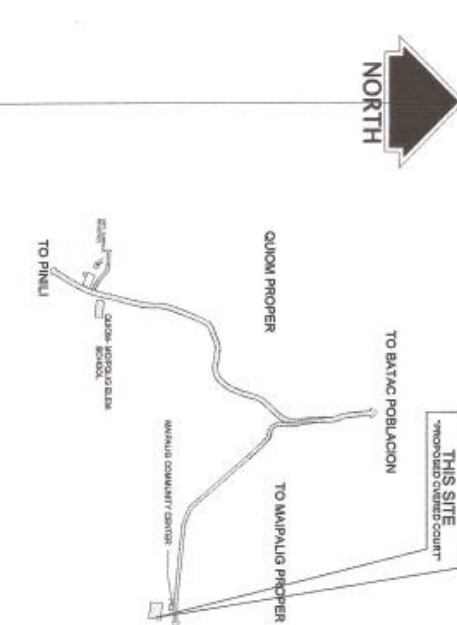
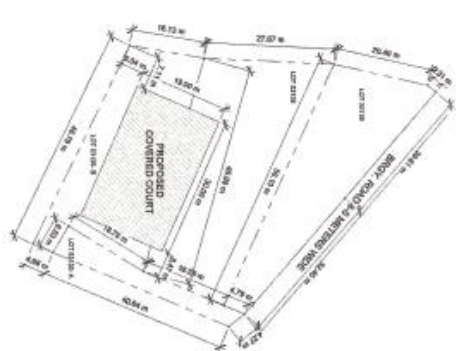

TABLE OF CONTENTS

1. SITE PLAN	A-1
2. EXTERIOR PERSPECTIVE	A-2
3. SITE DEVELOPMENT PLAN	B-1
4. VICINITY MAP	B-2
5. LAND USE AND ZONING	B-3
6. LINE AND GRADE	B-4
7. ARCHITECTURAL	B-5
8. STRUCTURAL	B-6
9. SANITARY	B-7
10. ELECTRICAL	B-8
11. MECHANICAL	B-9
12. BUREAU OF FIRE	B-10

2 SITE DEVELOPMENT PLAN  
SCALE A:1  
1:100 MTS

3 VICINITY MAP  
SCALE A:1  
1:200 MTS

REPUBLIC OF THE PHILIPPINES  
CITY ENGINEERING OFFICE  
PROJECT TITLE: PROPOSED COVERED COURT  
PROJECT LOCATION: MAIPALIG, CITY OF BATAC

DESIGNED BY: JAMES S. ALBERT D. CHUA  
CHECKED BY: JAMES S. ALBERT D. CHUA  
APPROVED BY: JAMES S. ALBERT D. CHUA

DATE: 11/15/2023

REPUBLIC OF THE PHILIPPINES  
CITY OF BATAC  
ENGR. ALBERT D. CHUA  
CITY ENGINEER

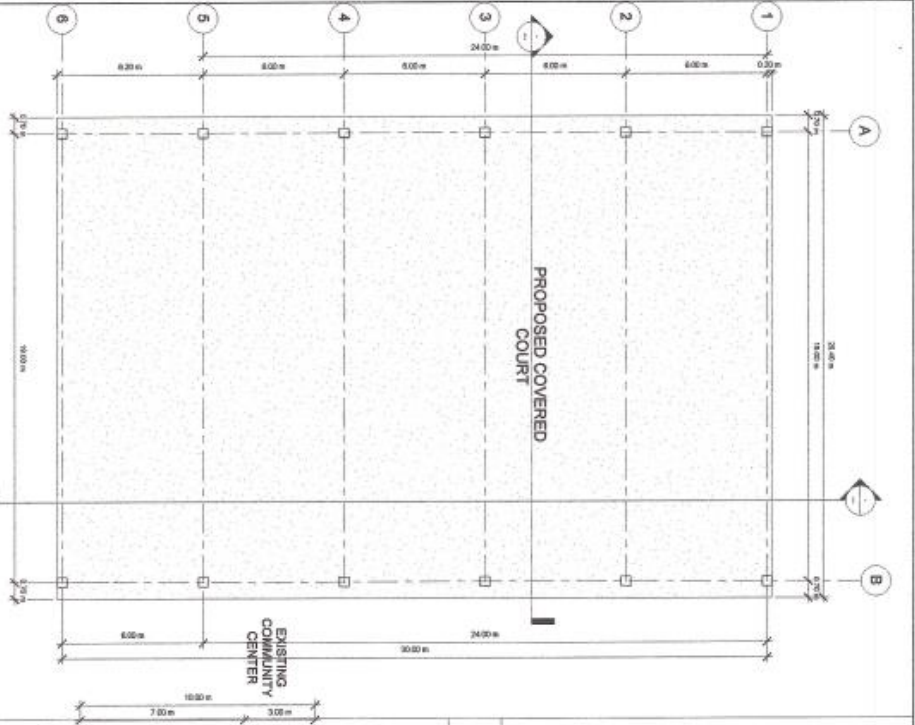

3 FLOOR PLAN  
SCALE 1:100  
A 2

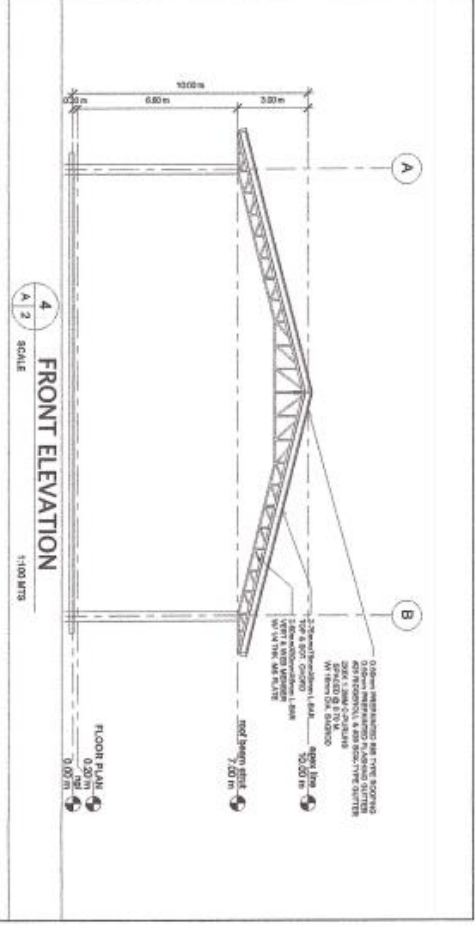

4 FRONT ELEVATION  
SCALE 1:100  
A 2

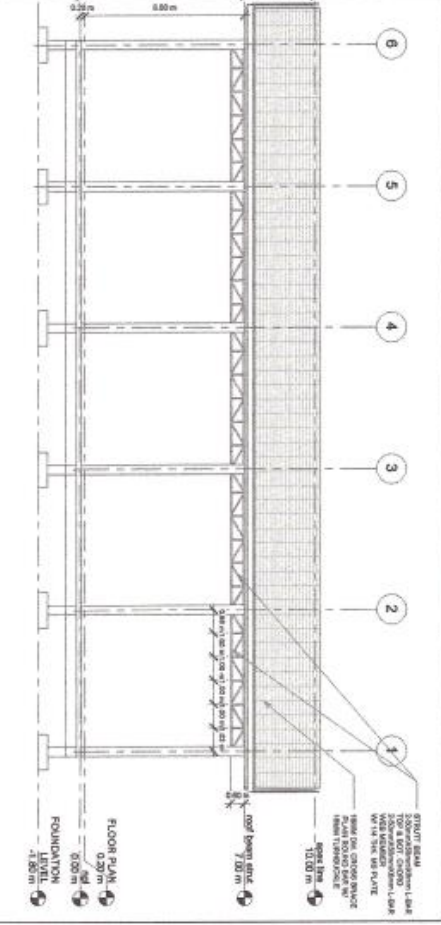

5 TYPICAL SIDE ELEVATION  
SCALE 1:100  
A 2

		REPUBLIC OF THE PHILIPPINES CITY ENGINEERING OFFICE PROJECT LOCATION: MALABON, CITY OF MANILA	
PROJECT TITLE <b>CONSTRUCTION OF COVERED COURT @ BRGY. MANALAY</b>		PROJECT LOCATION: MALABON, CITY OF MANILA	
PROJECT NO. 111 DATE: 11/18/2018		SHEET NO. 2 TOTAL SHEETS: 2	
DESIGNER: <b>ENGR. ALBERT D. CHUA</b> CITY ENGINEER		CHECKED BY: <b>ENGR. ALBERT D. CHUA</b> CITY ENGINEER	
APPROVED BY: <b>ENGR. ALBERT D. CHUA</b> CITY ENGINEER		DATE: 11/18/2018	



MUNICIPALITY OF MALABON  
 CITY ENGINEERING OFFICE  
 PROJECT NO. 14-10-2014-01  
 PROJECT LOCATION: 21 BERMAL ST. OF MALABON

PROJECT TITLE:  
 "CONSTRUCTION OF CONCRETE COLLEGE BRIDGE"

DATE SUBMITTED: 11/11/14  
 DRAWN BY: [Name]  
 CHECKED BY: [Name]

PROJECT NO.: 14-10-2014-01  
 PROJECT LOCATION: 21 BERMAL ST. OF MALABON

PROJECT TITLE:  
 "CONSTRUCTION OF CONCRETE COLLEGE BRIDGE"

DATE SUBMITTED: 11/11/14  
 DRAWN BY: [Name]  
 CHECKED BY: [Name]

PROJECT NO.: 14-10-2014-01  
 PROJECT LOCATION: 21 BERMAL ST. OF MALABON

PROJECT TITLE:  
 "CONSTRUCTION OF CONCRETE COLLEGE BRIDGE"

DATE SUBMITTED: 11/11/14  
 DRAWN BY: [Name]  
 CHECKED BY: [Name]

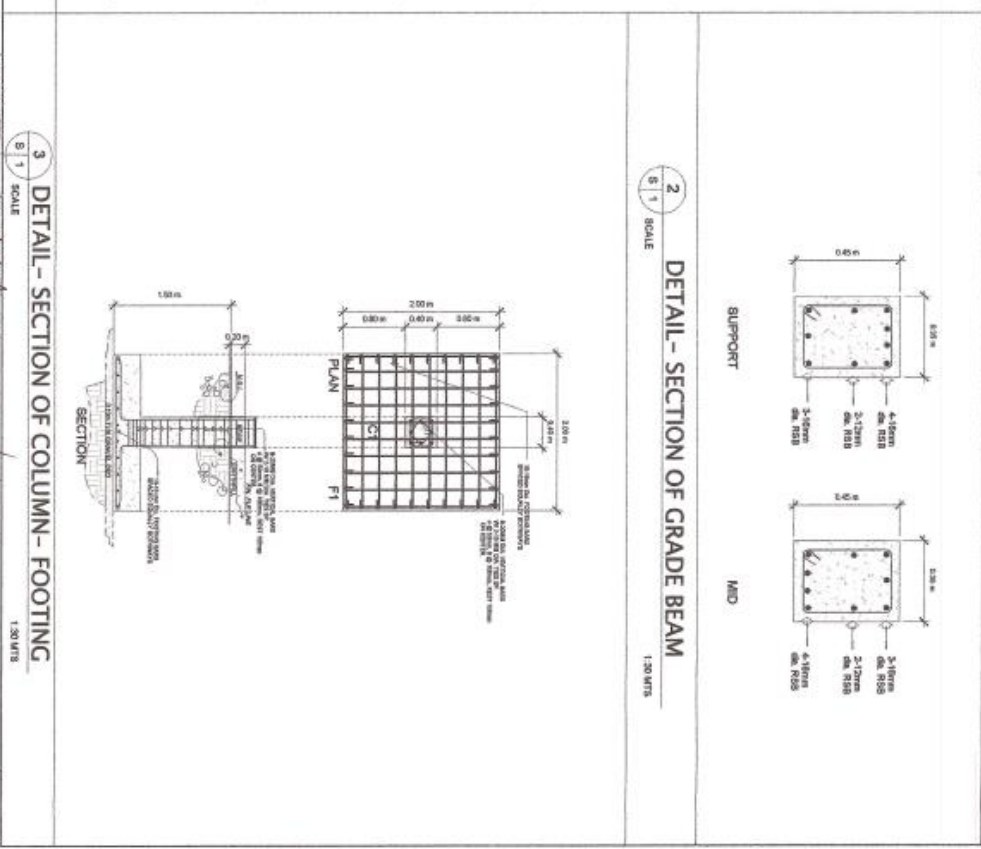
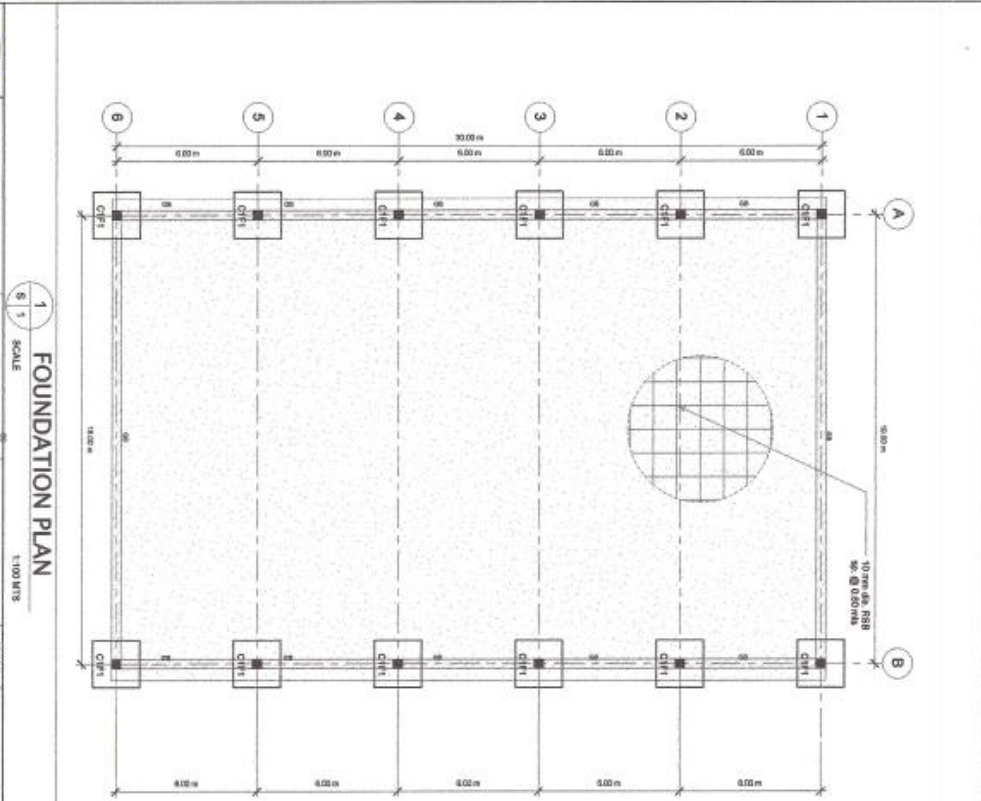

PROJECT NO.: 14-10-2014-01  
 PROJECT LOCATION: 21 BERMAL ST. OF MALABON

PROJECT TITLE:  
 "CONSTRUCTION OF CONCRETE COLLEGE BRIDGE"

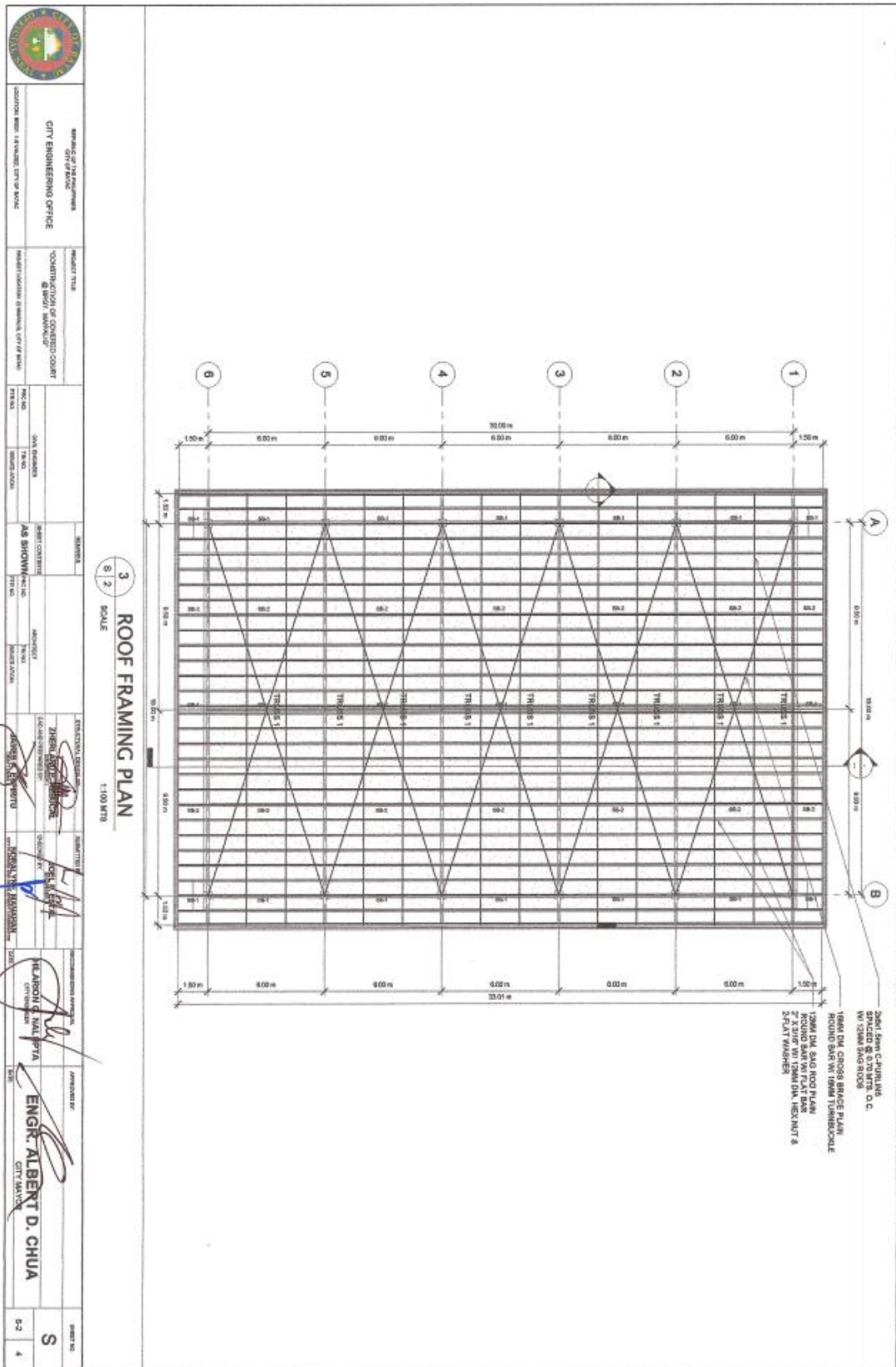

		<b>MUNICIPALITY OF MANILA</b> <b>CITY ENGINEERING OFFICE</b>		<b>COMMISSION OF CONCERNED CITIZENS</b> <b>OF MANILA (COCOMAN)</b>		<b>PROJECT TITLE</b> CONSTRUCTION OF CONCERNED CITIZENS OFFICE		<b>PROJECT LOCATION</b> 11000000, CITY OF MANILA	
<b>PROJECT NO.</b> 11000000		<b>DATE</b> 11/11/2023		<b>SCALE</b> 1:100 MTR		<b>DESIGNER</b> ENGR. ALBERT D. CHUA		<b>CHECKER</b> ENGR. ALBERT D. CHUA	
<b>APPROVED BY</b> 		<b>DATE</b> 11/11/2023		<b>PROJECT NO.</b> 11000000		<b>DATE</b> 11/11/2023		<b>PROJECT NO.</b> 11000000	



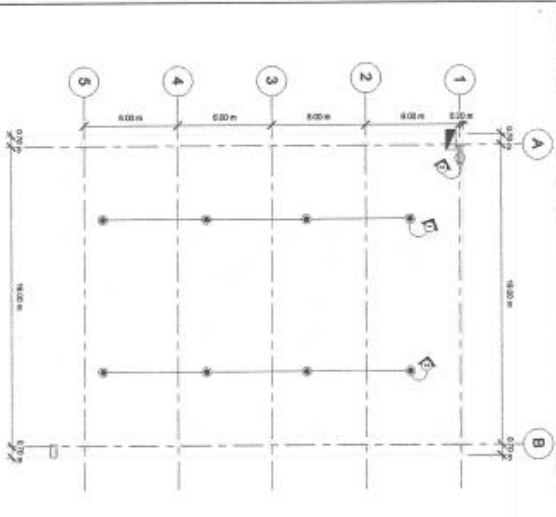

**1 LIGHTING & POWER LAYOUT**

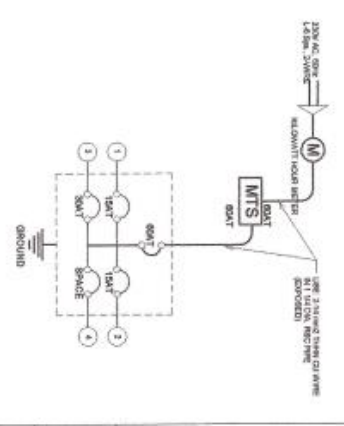

**2 SINGLE LINE DIAGRAM**

CIRCUIT NUMBER	LOAD DESCRIPTION	NUMBER OF SWITCHES				VA	VOLTS	CURRENT	CIRCUIT PROTECTION	WIRE	PVC CONDUIT
		L1	S1	S2	S3						
del 1	LIGHTING OUTLET @ 100W	4			400	240	2.61	15 AT 2P	2-3.5mm <sup>2</sup> THHN CU WIRE	25MM Ø	
del 2	LIGHTING OUTLET @ 100W	4			400	240	2.61	15 AT 2P	2-3.5mm <sup>2</sup> THHN CU WIRE	25MM Ø	
del 3	POWER CIRCUIT @ 200W	1			200	240	0.92	30 AT 2P	2-3.5mm <sup>2</sup> THHN CU WIRE	25MM Ø	
del 4	SPARE									25MM Ø	
					3200		6.12				

GENERAL LIGHTING LOAD  
 LIGHTING CIRCUIT 1200 VA  
 LIGHTING CIRCUIT 1200 VA  
 GROSS COMPUTED LOAD 1400 VA  
 NET COMPUTED LOAD 1400 VA  
 COMPUTATION OF PL  
 P.L. 1400 VA  
 P.L. 230 V  
 = 6.10 A

USE: 1 PAVE BOAT MCB, 100A  
 2-15mm<sup>2</sup> THHN CU WIRE IN  
 1.5ø DN RIS

**3 LOAD SCHEDULE AND COMPUTATION OF LOAD**

- 4 ELECTRICAL SYMBOL**
- POWER SERVICE ENTRANCE
  - RELOCATED FROM SECTION
  - PANEL BOARD
  - CIRCUIT BREAKER
  - CIRCUIT MAIN SWITCH
  - ONE GANG SWITCH
  - TWO GANG SWITCH
  - THREE GANG SWITCH
  - SSW THREE WAY SWITCH
  - FLOURESCENT LAMP CIRCUIT
  - CIRCUIT NUMBER
  - BUS OUTLET
  - 150 WATTS HIGH-BAY LIGHTS (LED)
  - LED PANEL LIGHT
  - COMMENCE OUTLET
  - ACU OUTLET
  - ELECTRIC CEILING FAN
  - EXHAUST FAN
  - ELECTRIC WATER PUMP

**4 ELECTRICAL SYMBOL**



**5 LOCATION PLAN**

**6 ELECTRICAL NOTES**

- ELECTRICAL WORKS INCLUDED HEREIN SHALL BE DONE IN ACCORDANCE WITH THE LATEST EDITIONS OF THE NATIONAL ELECTRICAL CODE AND THE LOCAL ELECTRICAL COOPERATIVE (INCO).
- ALL WIRINGS SHALL BE INSTALLED BY STAKEHOLD PIVOT SCHEDULE 40 SHEATHED INSURE NON-LOW FLOOR STRUCTURES OR NON-BETWEEN CEILING AND ROOFING.
- ALL SPICES SHALL BE MADE AT JUNCTION BOXES AND OTHER LINE APPROVED MATERIALS FOR PARTICULAR PURPOSES.
- CONDUITING HEIGHT
  - A. CONDUITING OUTLETS 1.20 METERS
  - B. PANEL BOARD 0.30 METERS
  - C. WALL PLUGS 1.50 METERS
- SERVICE LINE TO BE USED SHALL BE 230 V, 60 HZ
- VENUEY POINT OF POWER SERVICE ENTRANCE
- WIRINGERS REQUIRED OR NECESSARY PULL BOXES AND JUNCTION BOXES SHALL BE INSTALLED AT CONVENIENT LOCATIONS, ALTHOUGH SUCH BOXES ARE NOT SHOWN.
- ALL ELECTRICAL WORKS SHALL BE DONE UNDER THE SUPERVISION OF A DULY LICENSED ELECTRICAL ENGINEER OR MASTER'S ELECTRICIAN

MEMORANDUM FOR THE ENGINEER  
 CITY ENGINEERING OFFICE

PROJECT TITLE: TOYKALAN  
 TOYKALAN DIVISION OFFICE  
 @ BAYTAG, BAYAG

OPERATION NO. 14 (MAY 2018) CITY OF BAYAG

DATE: 05/15/2018

DESIGNED BY: ENGR. ALBERT D. CHUA  
 CHECKED BY: ENGR. ALBERT D. CHUA  
 APPROVED BY: ENGR. ALBERT D. CHUA

ISSUED AT: CITY ENGINEERING OFFICE  
 PROJECT NO. 14 (MAY 2018) CITY OF BAYAG

DATE: 05/15/2018

ENGR. ALBERT D. CHUA  
 CITY ENGINEER

## *Section VIII. Bill of Quantities*

## Section VIII. Bill of Quantities

B.3	Permits and Clearances	l.s.	1.00	<u>In words:</u> <u>In Figures:</u>	In Figures:
B.5	Project Billboard/ Signboard	Ea.	1.00	<u>In words:</u> <u>In Figures:</u>	In Figures:
B.7(2)	Occupational Safety and Health Program	l.s.	1.00	<u>In words:</u> <u>In Figures:</u>	In Figures:
B.9	Mobilization / Demobilization	l.s.	1.00	<u>In words:</u> <u>In Figures:</u>	In Figures:
801(1)	Removal of Structures and Obstruction (Concrete)	l.s.	1.00	<u>In words:</u> <u>In Figures:</u>	In Figures:
803(1)a	Structure Excavation(Comm on Soil, Manual Excavation)	Cu. m.	119.71	<u>In words:</u> <u>In Figures:</u>	In Figures:
804(1)a	Embankment from Structure Excavation	Cu.m.	57.60	<u>In words:</u> <u>In Figures:</u>	In Figures:
804(1)b	Embankment from Borrow	Cu.m.	138.31	<u>In words:</u> <u>In Figures:</u>	In Figures:
804(4)	Gravel Fill	Cu.m.	28.50	<u>In words:</u> <u>In Figures:</u>	In Figures:
900(1)c1	Structural Concrete (Class A), 28 Days	Cu.m.	100.80	<u>In words:</u> <u>In Figures:</u>	In Figures:
902(1)b	Reinforcing Steel (Deformed), Grade 60	Kgs.	7,780.92	<u>In words:</u> <u>In Figures:</u>	In Figures:
903(1)	Formworks and Falseworks	Sq..m.	266.20	<u>In words:</u> <u>In Figures:</u>	In Figures:
1046(2)a 1	100mm CHB Load Bearing (including Reinforcing Steel)	sq.m.	20.16	<u>In words:</u> <u>In Figures:</u>	In Figures:



1027(1)	Cement Plaster Finish	Sq.m.	20.16	<u>In words:</u> <hr/> <u>In Figures:</u>	In Figures:
1032(1)c	Painting Works (Steel)	Sq.m.	1,604.38	<u>In words:</u> <hr/> <u>In Figures:</u>	In Figures:
1014(1)b 2	Prepainted Metal Sheets, (Long Span, Rib type, Above 0.50mm thk)	Sq.m.	759.00	<u>In words:</u> <hr/> <u>In Figures:</u>	In Figures:
1013(2)a 1	Fabricated Metal Roofing Accessory (Ridge/Hip Rolls, GA 24)	l.m.	33.00	<u>In words:</u> <hr/> <u>In Figures:</u>	In Figures:
1013(2)a 2	Fabricated Metal Roofing Accessory (Flashing, GA26)	l.m.	45.60	<u>In words:</u> <hr/> <u>In Figures:</u>	In Figures:
1013(2)b 1	Fabricated Metal Roofing Accessory (Gutters, GA 24)	l.m.	66.00	<u>In words:</u> <hr/> <u>In Figures:</u>	In Figures:
1047(2)	Structural Steel	Kgs.	19,359.15	<u>In words:</u> <hr/> <u>In Figures:</u>	In Figures:
1100(10)	Conduits, boxes, and Fittings (conduit works/Conduit Rough in)	l.s.	1.00	<u>In words:</u> <hr/> <u>In Figures:</u>	In Figures:
1101(33)	Wires and Wiring Devices	l.s.	1.00	<u>In words:</u> <hr/> <u>In Figures:</u>	In Figures:
1102(1)	Panelboard with Main and Branch Breakers	l.s.	1.00	<u>In words:</u> <hr/> <u>In Figures:</u>	In Figures:
1103(1)	Lighting fixtures and lamps	l.s.	1.00	<u>In words:</u> <hr/> <u>In Figures:</u>	In Figures:
1001(6)	Catch Basin	l.s.	1.00	<u>In words:</u> <hr/> <u>In Figures:</u>	In Figures:
1001(9)	Storm Drainage and Downspout	l.s.	1.00	<u>In words:</u> <hr/> <u>In Figures:</u>	In Figures:

1711(1)	Stone Masonry	Cu.m.	92.49	<u>In words:</u>	In Figures:
				<u>In Figures:</u>	

## ***Section IX. Checklist of Technical and Financial Documents***

# Checklist of Technical and Financial Documents

## I. TECHNICAL COMPONENT ENVELOPE

### *Class "A" Documents*

#### Legal Documents

- (a) Valid PhilGEPS Registration Certificate (Platinum Membership) (all pages);  
**or**

#### Technical Documents

- (e) Statement of the prospective bidder of all its ongoing government and private contracts, including contracts awarded but not yet started, if any, whether similar or not similar in nature and complexity to the contract to be bid; **and**
- (f) Statement of the bidder's Single Largest Completed Contract (SLCC) similar to the contract to be bid, except under conditions provided under the rules; **and**
- (g) Philippine Contractors Accreditation Board (PCAB) License;  
**or**  
Special PCAB License in case of Joint Ventures;  
**and** registration for the type and cost of the contract to be bid; **and**
- (h) Original copy of Bid Security. If in the form of a Surety Bond, submit also a certification issued by the Insurance Commission;  
**or**  
Original copy of Notarized Bid Securing Declaration; **and**
- (i) Project Requirements, which shall include the following:
- a. Organizational chart for the contract to be bid;
- b. List of contractor's key personnel (*e.g.*, Project Manager, Project Engineers, Materials Engineers, and Foremen), to be assigned to the contract to be bid, with their complete qualification and experience data;
- c. List of contractor's major equipment units, which are owned, leased, and/or under purchase agreements, supported by proof of ownership or certification of availability of equipment from the equipment lessor/vendor for the duration of the project, as the case may be; **and**
- (j) Original duly signed Omnibus Sworn Statement (OSS);  
**and** if applicable, Original Notarized Secretary's Certificate in case of a corporation, partnership, or cooperative; or Original Special Power of Attorney of all members of the joint venture giving full power and authority to its officer to sign the OSS and do acts to represent the Bidder.

#### Financial Documents

- (k) The prospective bidder's audited financial statements, showing, among others, the prospective bidder's total and current assets and liabilities, stamped "received" by the BIR or its duly accredited and authorized institutions, for the preceding calendar year which should not be earlier than two (2) years from the date of bid submission; **and**
- (l) The prospective bidder's computation of Net Financial Contracting Capacity (NFCC).

### *Class "B" Documents*

- (m) If applicable, duly signed joint venture agreement (JVA) in accordance with RA No. 4566 and its IRR in case the joint venture is already in existence;  
**or**

duly notarized statements from all the potential joint venture partners stating that they will enter into and abide by the provisions of the JVA in the instance that the bid is successful.

## II. FINANCIAL COMPONENT ENVELOPE

- (n) Original of duly signed and accomplished Financial Bid Form; **and**

### *Other documentary requirements under RA No. 9184*

- (o) Original of duly signed Bid Prices in the Bill of Quantities; **and**
- (p) Duly accomplished Detailed Estimates Form, including a summary sheet indicating the unit prices of construction materials, labor rates, and equipment rentals used in coming up with the Bid; **and**
- (q) Cash Flow by Quarter.

